

EX-6 series

HITACHI

EX

8000



HYDRAULIC EXCAVATOR

- **Model Code** : EX8000-6
- **Engine Gross Power** : 2 x 1 450 kW (2 x 1 940 HP)
- **Operating Weight** : Loading Shovel : 811 000 kg
- **Loading Shovel Bucket** : Heaped : 40.0 m³

Ultra Large Sized Production from the Hitachi Gigantic Excavators

The Hitachi Giants Yield Amazing
Mining Production...
Setting a New Standard



Note: Photos in this brochure may include optional equipment.
They may also include custom-made options to meet specific user needs.

SOLUTION GIANT

Giant-Sized Productivity Based on Hitachi's Theory of Evolution.

Each Hitachi generation listens to the needs of the work site and gives birth to an even-better new generation.

Powerful Engines— Ready for the task.

Time-proven twin Cummins diesel engines produces a total of 2 X 1 450 kW (2 X 1 940 HP) for handling the big excavation jobs.

- 2 x 1 450 kW (2 x 1 940 HP)

Emission Control Engine— Helping to protect our environment.

Conforms to U.S. EPA Tier II emission regulations.

Efficient E-P Control— Adjusts power output to the work being performed.

Hitachi's computer-aided Engine-Pump Control (E-P Control) coaxes optimum efficiency from the engines and hydraulic pumps. This innovative system senses load demand and controls engine and pump output for maximum operating efficiency.

Flow-Assisting Circuit— Allows dynamic actions.

Using the meter-in valves, ample-capacity make-up valves, and flow-assisting pumps, the flow speed is increased in cylinders for dynamic actions. Especially, between dumping and digging.



Larger Bucket Provides High Work Capacity.

- Loading shovel bucket : 40.0 m³

Maximum Excavating Force.

- Crowding force : 2 870 kN (293 000 kgf)
- Breakout force : 2 230 kN (227 000 kgf)

Large Bucket— Designed to enhance efficiency.

The large bucket has been shaped specifically to enhance scooping and loading operations. Its sharp tilt angle helps boost operating efficiency.

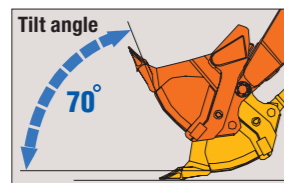

Bucket Passes to Dump Trucks

HITACHI EH5000	
Nominal Payload	286 tonnes
Load Capacity <small>(SAE 2:1 Heaped)</small>	196 m ³
Loading Shovel 40.0 m ³	4



SOLUTION GIANT

More Than Durable — Just Plain Tough

Built-in toughness means the Hitachi will continue to get giant-sized jobs done fast.



Rigid Box Design— Resists bending and twisting forces.

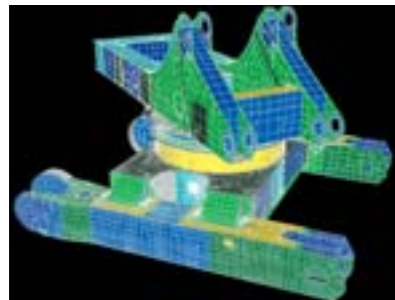

Computer-assisted analysis was used to check that the frame box can withstand heavy-duty excavation work.

Solid Cast Track Frame— More strength for this key area.

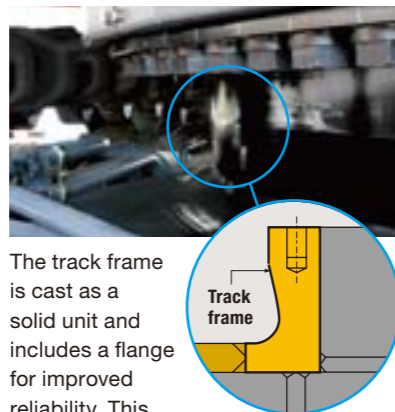

The track frame is cast as a solid unit and includes a flange for improved reliability. This non-welded design is used exclusively on large Hitachi models.

Rugged Lower Rollers, Track Links and Drive Tumblers— Help to boost durability at rough tough work sites.

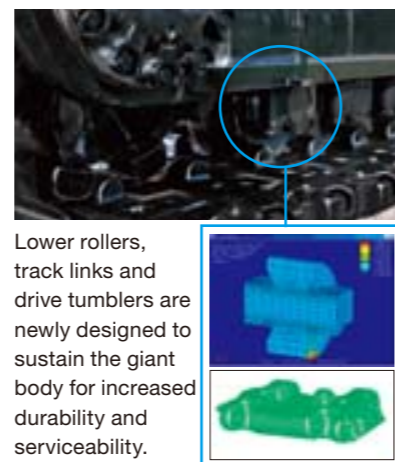

Lower rollers, track links and drive tumblers are newly designed to sustain the giant body for increased durability and serviceability.

Constant Correct Track Tension— Nitrogen gas accumulators absorb abnormal track tension.

Helps prevent abnormal track tension from causing damage. Travel is automatically stopped if accumulator pressure exceeds a preset level. At this time, alert information and countermeasures are indicated on the multi-display monitor.

Flow-Retarding Control at Cylinder Stroke Ends— Improves controllability with longer service life.

When nearing 30 cm ahead of the cylinder stroke end, the flow and pressure are reduced to retard the cylinder movement. This helps reduce impact at the stroke end to increase controllability and to extend service life. This mechanism is provided for arm/bucket roll-in and roll-out.

Strategically Positioned Oil Coolers— Helps keep oil temperatures lower.

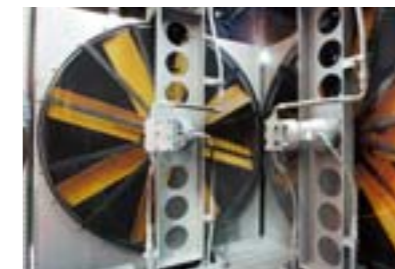

Three oil coolers are used for optimal cooling efficiency. They are positioned far from the engine radiator for even better cooling potential.

High-Pressure Filter— Provides clean oil.



Hydraulic oil is filtered at high pressure to remove damage-causing contaminants. This filter is positioned down-line from the pumps to help prevent damage in the rare event of pump failure. Positioned for easy maintenance.



SOLUTION GIANT

Designed to Offer Comfort and Intelligence

Comfortable operator space and simplified maintenance, backed by Hitachi technologies and experience.

High Visibility 9.0 Meter Cab Height— Providing a clear view of the work area.

Gives the operator a clear view, even when a large 300 tonnes class dump truck is being loaded. This high height and forward-sloping cab provides a view that boosts productivity.

Rugged Comfortable Cab— Protects the operator from falling objects.

Fluid filled elastic mounts help absorb vibration to provide durability and a comfortable ride. The top guard, conforming to OPG* level II (ISO), is provided on the cab roof.

*Operator Protective Guard



Plenty of Utility Space— Allows full 24-hour operation.

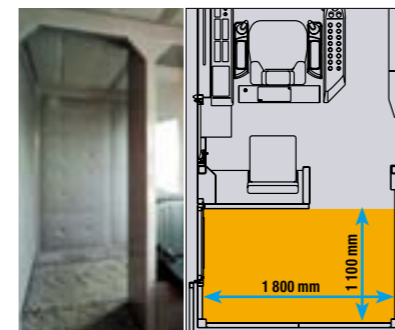

Plenty of utility space is provided behind the operator seat to hold a table, electronic oven, and refrigerator. This allows a full 24-hour operation for higher productivity.

Efficient Cab Layout— All controls within natural reach of operator.

The ergonomic layout of the cab means the operator will do less stretching and reaching when operating the controls. This adds up to less operator fatigue and greater operating efficiency.

Electric Joystick Levers— Provides pleasant control with less fatigue.



Electric joystick control levers have a feather-touch allowing long periods of effortless operation. Its stroke is much shorter than that of hydraulic control.

Air Suspension Seat with Auto Operator Weight Adjuster.

The operator seat cushion can automatically be adjusted according to the operator weight. This is convenient for a machine operated by two or more operators.

Adjustable Sliding Cockpit— Moves to the best position for the operator.

The operator can adjust the position of the levers and the seat to custom fit his size and operating style.

Constant-Cab-Comfort Air Conditioner— Keeps the cab pressurized to keep out dust while maintaining comfortable temperature.



Intelligent Multi-Display Monitor provides machine data and operating status at a glance.



* Illustration shows a sample of the Emergency Switch.

The operator can monitor machine conditions and operating status with a 10.5-inch color LCD. The controller provides instant fault diagnosis through all sensors, displaying warnings and countermeasures if failure arises.

Major Functions:

- Multiple meters, and alert symbols indication
- Alert/failure status, and countermeasures indication
- Snap-shot function that stores operating data, including five-minute operating data immediately before alerting, and succeeding one-minute data (temperatures, pressures, and more)
- Setting oil change intervals with alerting

Much more functions are provided to ease maintenance and servicing.

Outside Cameras (Optional)— Enhances operator's visibility.

The operator can monitor around the machine, using four cameras (optional) to eliminate blind spots.



SOLUTION GIANT

Designed to be Maintainable

Carefully engineered to allow full 24-hour operation.



Easier Access and Wide Open Service Area— Provides the space needed for quick and easy inspection and maintenance.

The wide fender, spacious counterweight top and central passage give easy access to major components for convenience of inspection and maintenance. This means faster and safer inspection and maintenance.

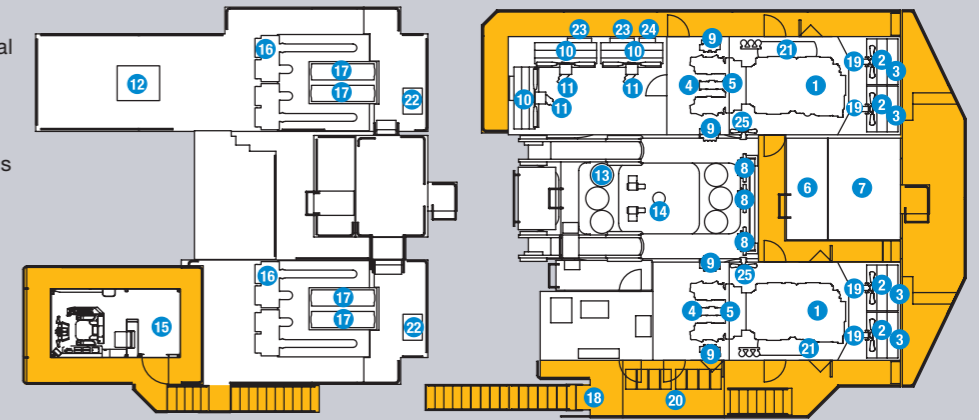

- | | | | |
|----------------------------|--|----------------------------------|--------------------------------|
| 1 Engine x 2 | 8 Control Valve x 6 | 15 Cab | 22 Reserve tank (coolant) x 2 |
| 2 Engine Radiator x 4 | 9 High-Pressure Strainer x 16 | 16 Air Filter x 4 | 23 Pump mission oil cooler x 2 |
| 3 LTA Radiator x 4 | 10 Hydraulic Oil Cooler x 6 | 17 Muffler x 4 | 24 Fuel cooler x 2 |
| 4 Hydraulic Pump x 16 | 11 Hydraulic Oil Cooling Fan Motor x 3 | 18 Folding Stairs | 25 Engine room Cooling Fan x 2 |
| 5 Engine-Pump Bulkhead x 2 | 12 Lubricator | 19 Fan Motor x 8 | |
| 6 Hydraulic Oil Tank | 13 Swing Device x 6 | 20 Battery Unit | |
| 7 Fuel Tank | 14 Center Joint | 21 Reserve tank (engine oil) x 2 | |

Folding Stairs with Wide Steps.



Folding stairs is designed for easy access to the machine for servicing and maintenance.

Auto Lubrication System—Eliminates the need for manual lubrication.

This system automatically lubricates the front joint pins and swing circle. This eliminates cumbersome daily lubrication. A spare pump is provided standard for the auto lubrication system.

The Centralized Lubrication System: Fast Filling System

Easy Bucket Tooth Replacement—This area is designed to be easily maintained.

Innovative bucket tooth and shrouds are used to cut maintenance time.

Convenient 24 Volt DC Crane—Helps lift important items into place (Optional).

This is a handy item when handling heavy tools or other items.

Protective Engine and Pump Bulkhead—Contributes to lower heat and less potential for damage.

Steel barrier keeps these two areas independent.

Low Maintenance Dust Ejector—Automatically expels dust from the air cleaner.

This is one less time-consuming task during routine maintenance.

Contamination Sensor—Alerts the operator of excessive contaminants in the oil.

This system detects accumulated contaminants that could cause damage and alerts the operator before trouble occurs.

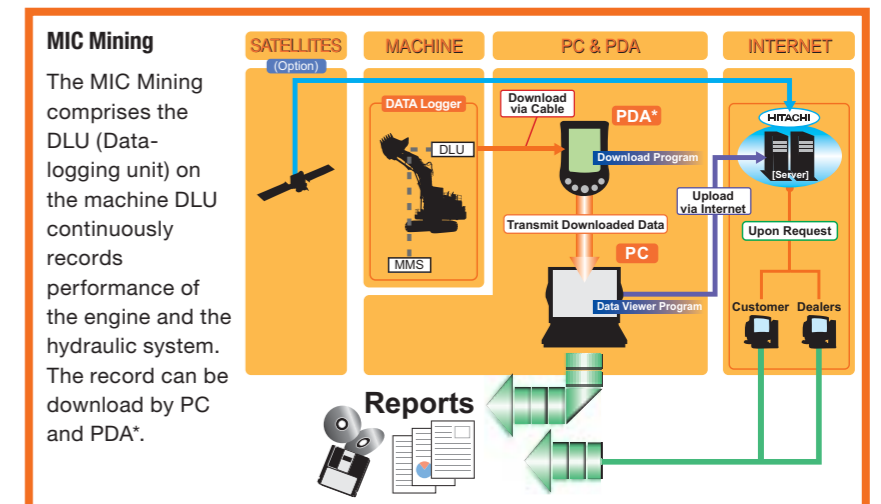

* Personal Digital Assistant

